

Neon

New generation
workplace chairs

bimos

Neon – for the new generation of work

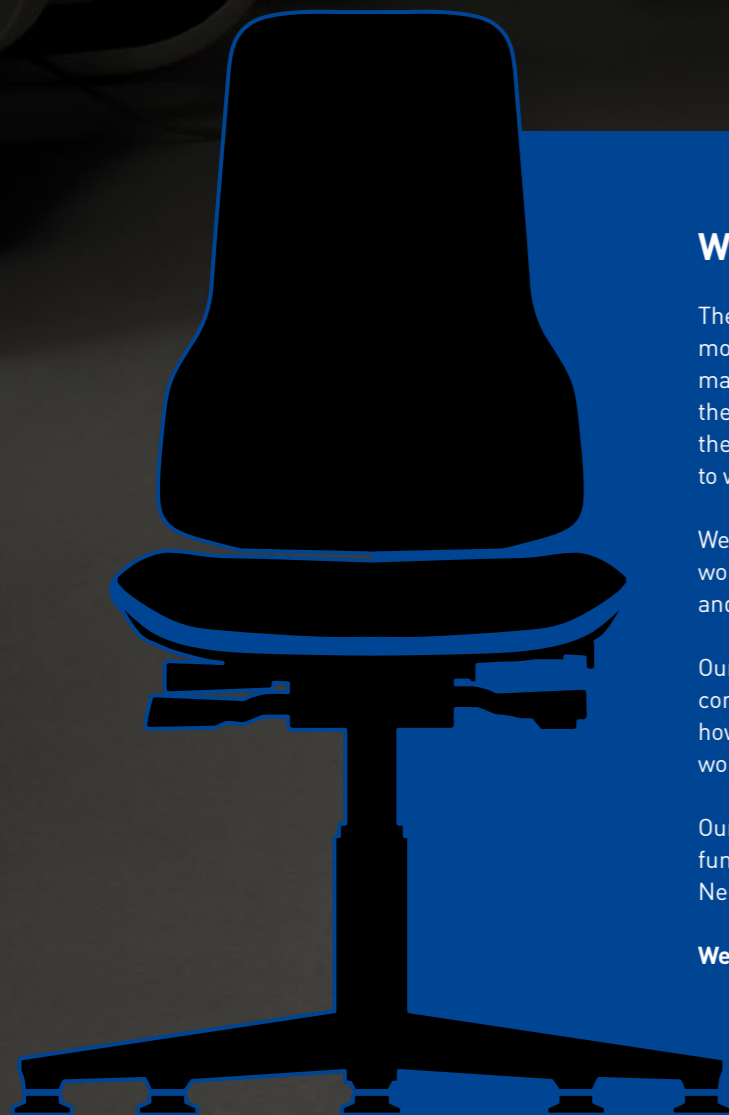

We are bimos,

The leading producer of workplace chairs in Europe. For more than 50 years we have been developing and manufacturing seating solutions for workplaces outside the office: in production, in ESD areas, in the laboratory, in the clean room, and in any areas where people have to stand to work.

We look at the chair as a tool that has to support people at work in the best possible way. The chair connects people and their work. For people, their chair is their workplace.

Our seating solutions are always developed with a combination of practical experience and research. This is how we are able to offer the best possible solution for any work situation.

Our capacity to innovate and our experience are fundamental strengths that have enabled us to develop Neon – the best workplace chair in the world.

Welcome to bimos.



Neon is the new workplace

Neon is a product of experience, research and practice

The development by bimos of a new chair is based on three fundamental principles: our programme "From practical experience for practical application" provides the perfect practical fit. Our close co-operation with the Fraunhofer IAO helps us make sure that our products always correspond with the latest cutting-edge research into working practices, and are future-proof. And our experience of more than 50 years in the field of development and manufacture of workplace chairs guarantees the highest possible product quality. This is how we constantly set new standards in workplace chairs. And the latest standard is Neon.

Work is changing

Simple jobs in manufacturing are more and more being replaced by more complex and demanding tasks. So the demands on your employees are also increasing. A company that wants to attract and keep qualified employees has to provide ideal working conditions. And ideal working conditions begin with an ideal workplace chair – they begin with Neon.



Your employees deserve the best

Nothing defines a workplace so much as a chair. That is where a person spends most of his or her working day. This means that the chair has an enormous influence on wellbeing at work. Together with its great ergonomics and top quality comfort, it also creates an emotional identification with the workplace and contributes significantly to the extent to which an employee feels comfortable at work and in your company. A good chair is an indication of how much one is appreciated. We are sure that appreciation is the most important step towards added value. Take this step with Neon.

An investment in motivation, productivity and efficiency

The latest research shows that future production systems will place other requirements on work equipment, in other words on machines, equipment, work tables and workplace chairs. This means that there are not only higher demands on technical features, but also on the quality of design. An employer who wants highly motivated, productive employees has to recognise that all the components of the system of working must contribute to this motivational effect. High quality design and facilities can provide potential scope for improvement of up to 36%. What is more, a good workplace chair helps prevent tiredness, and promotes concentration. Raise the quality of your work with Neon.

Modernise your production

These days, it is not just the product that is important, it is also the way in which the product is produced. This starts from questions about certification, to occupational health and safety, right through to the showcase function of production lines, as in the case of "transparent production". High-class seating solutions that are tailored to a particular kind of work will enhance production areas. Modernise your production with Neon.

Neon is made for industry ...

... and is at home in industry

- low-maintenance
- washable
- robust
- easy to repair
- tough
- durable
- 5 year warranty
- economical
- adaptable
- flexible
- conforming to body shape
- ergonomic
- freely configurable
- right upholstery for every application
- safe and conforming to standards (GS)



-  production areas
-  research and development
-  work places with many different users
-  high workplaces
-  low workplaces
-  ESD workplaces
-  laboratory workplaces
-  workplaces in which maximum freedom of movement is necessary

Neon is the
all-round specialist



Neon is brilliantly equipped for every use

The right version for every workplace

The variations of the Neon are just as diverse as the many different requirements of workplaces. No matter if the chair is to be used at a high or low workplace, whether it

has glides or castors, or whether it is needed for specialist use in production, or in ESD areas or laboratories: Neon is always Neon.



Neon 1
with glides

Neon 2
with castors

Neon 3
high with mounting aid and glides

Synchronous technology
or
Permanent contact

Synchronous technology
or
Permanent contact

Synchronous technology
or
Permanent contact



Production

In the field of manufacturing the highest demands are placed on the resilience and robustness of the chair and the materials.

Laboratory

In the laboratory, materials must be washable and resistant to disinfecting agents. Furthermore, surfaces with as few joints and seams as possible make cleaning easier.

ESD

bimos ESD chairs fulfil the requirements of the EN 61340-5-1 standard for use in ESD protected areas (EPAs). By choosing the best possible materials and joining technologies, bimos chairs ensure that electrostatic charges can be safely eliminated. Typical discharge resistance is $10^6 \Omega$.

Just choose your upholstery

Every working environment presents its own demands in terms of upholstery and cover materials. For this reason, there are four different upholstery choices for Neon: Taff fabric, Magic synthetic leather, integral foam, or

Superfabric, a world first among cover materials. Regardless of the surface you choose, Neon offers the maximum quality, sitting comfort and pleasant sitting climate.

Taff fabric

- breathable
- comfortable
- soft
- hard-wearing



Integral foam

- extremely tough and durable
- washable
- capable of withstanding mechanical damage
- resistant to flying sparks
- impervious to mild acids and alkalines



Magic synthetic leather

- washable
- low-maintenance
- impervious to oil and disinfecting agents
- soft and comfortable



Superfabric

Superfabric, a **world first** among cover materials. It is very robust and breathable at the same time.

- comfortable and soft
- breathable
- very robust
- cut resistant
- non slip
- easy to clean

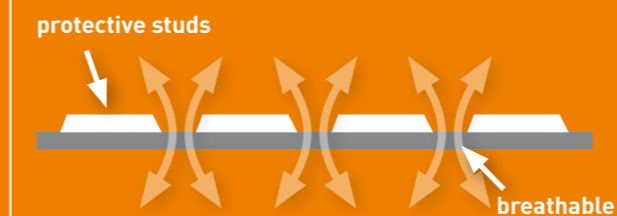

Partly hard, yet overall very soft.

Neon – a new vision of ergonomics and comfort



Neon – ergonomics means adaptability, comfort and intuition

The human body is the measure

Neon creates something that has until now been considered impossible in the field of workplace chairs: it adapts to the work situation just as well as it adapts to people, and is extremely comfortable. In spite of being perfectly suited to industrial use, Neon does not compromise on ergonomic features.



Neon makes ergonomics comfortable

The characteristics that were previously reserved for office workplaces are now brought into the production area by Neon: best possible support for the body, outstanding sitting climate and top comfort. It is above all the ergonomic shape of the upholstery that is responsible for this comfort. Although Neon has a slim appearance, it has very generous upholstery.

Neon speaks for itself

To make a chair perfectly adaptable, it has to have a great many adjustment possibilities; but these only fulfil their purpose when they can be used. So it is essential that the chair can be used intuitively. This becomes even more important when different people are using the same chair in production areas, as is frequently the case. In spite of offering such a wide range of adjustment options, the intelligent design of the operational controls allows Neon to speak for itself, even at a distance.

Academic research convinced by Neon

On the basis of the findings of the Arbeitswelt (Working Environment) 2015^{plus} research, the Fraunhofer IAO produced an expert opinion on Neon, coming to the following conclusion: *"In summary, it is clear to see that the new Neon workplace chair by bimos shows great potential for revolutionising the working environment, and above all production. In the production environments of the future, the Neon will give people an experience they will appreciate deeply, and introduce some real quality into their place of work. This will encourage people and motivate them to contribute to the success of the company."*

Neon – the many shapes of ergonomics

Adjust the chair, not the person

People working in manufacturing workplaces may use a good deal of energy, or they may be doing delicate work; in either case they often make repetitive movements, and it is not always easy to find an ideal position in relation to the workpiece. So in order to provide active-dynamic sitting,

and to avoid forced postures, a chair has to be perfectly adapted to the work environment and to people. Neon is the first workplace chair that genuinely fulfils this requirement, thereby protecting the health and productivity of employees.

The ergonomics package – Neon is all-inclusive



Neon has the technology
Neon can be adjusted in every possible way to cater for different body sizes and weights on the one hand, and the most varied activities on the other.

- **Height adjustment**
Height adjustment allows adjustment to body size and height of workplace. The adjustment range of Neon – up to 280 mm – is particularly large.
- **Seat inclination adjustment**
Many jobs in manufacturing are carried out in slightly raised positions, and require people to bend forward. A correspondingly inclined seat provides a seat angle of at least 90° while at the same time providing contact with the backrest.
- **Seat depth adjustment**
The seat depth adjustment matches the depth of the seat to the size of the body, giving the best possible contact surface for the thighs. Contact with the backrest, and therefore the support it provides, are maintained.

Choice of two basic mechanisms for active-dynamic sitting

Two mechanical concepts are available: the permanent contact backrest, and synchronous technology.

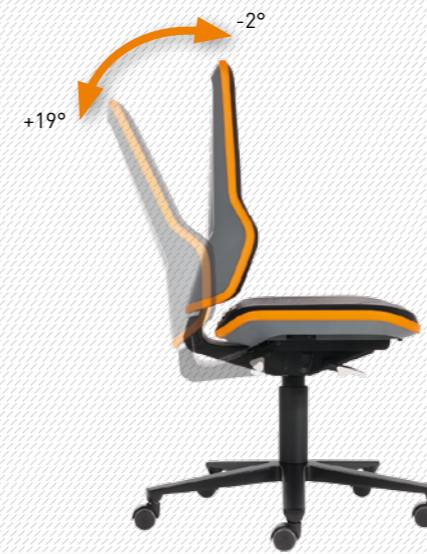

The permanent contact backrest ...

... follows the user's movements, and ensures that the back always remains fully supported. The weight regulation ensures that the balance between the resistance of the backrest and the body weight is always steady. The permanent contact backrest is ideal for work where people have to lean forward for a long time, with only a small distance between eyes and workpiece (e.g. working at close range or in the laboratory).



Synchronous technology ...

... provides an active-dynamic sitting experience with weight regulation. The seat and backrest accompany the body as it moves. This gives the user a feeling that can best be described as "weightless floating". The synchronous technology comes into its own where users are working at desk-related jobs, working at a screen, or constantly changing their sitting position.

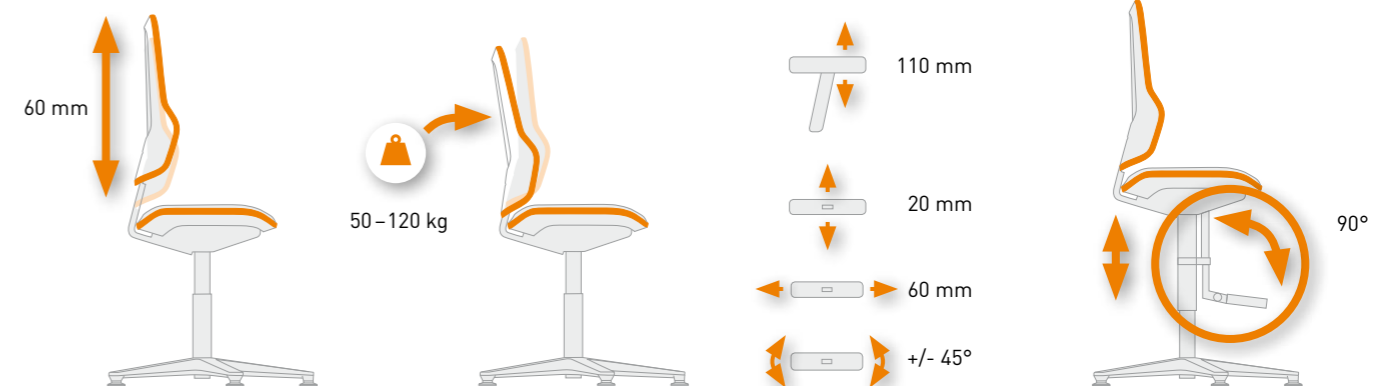

• **Backrest height adjustment**
The backrest height adjustment ensures that a person is ideally supported – above all in the lumbar region – no matter how tall he/she is.

• **Weight regulation**
By adjusting the pressure of the backrest, both light and heavy people can sit with the correct posture.

• **4D armrests**
To reduce the strain on the upper body and arms, the height, breadth and depth of Neon's 4D armrests can be adjusted, and can also be swivelled.

• **Foot support and mounting aid**
The mounting aid rotates with the seat height adjustment as well as when the seat is swivelled, so is always exactly in the right position. The very large step provides good grip; its height is adjustable, and it can be folded upwards by 90°.

1+1=Neon



1+1: the Neon system

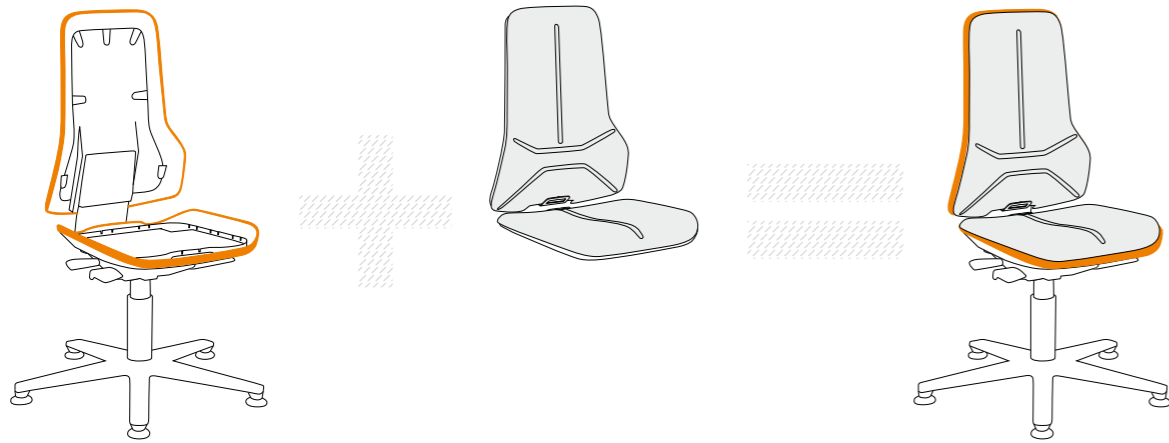

Neon consists of two elements: the chair element with base and mechanism and the upholstery element. Both elements can be configured independently and are freely combinable. This offers many advantages:

- **Sustainability:** When new upholstery is needed, you do not need to dispose of the whole chair.
- **Flexibility:** If Neon is to be used in another area of work, it is only the upholstery element that needs to be changed.
- **Economy:** A single investment in a chair, and then only replace upholstery when necessary.
- **Individuality:** Upholstery determines use: changing upholstery surfaces suit changing uses.
- **Speed of delivery:** The modular construction means that not every chair has to be individually made after an order is received. This leads to extremely short delivery times.
- **Changeable upholstery:** Different employees in the same workplace – for instance on multiple shift work – can use their own personal upholstery.



Easy change of upholstery

The 1+1 system makes child's play of the change of upholstery: the upholstery elements are simply placed on the chair and fixed with a click. To make the removal of the element as easy as possible, each upholstery element is provided with a little grip.



Neon – the new form
of function



Neon redesigns the world of working

Neon defines the new face of production work

The workplace and design quality of production areas is becoming more and more similar to office spaces. For quite some time now, the visual appearance of machines in production halls has become a prominent factor. In as far as workplace chairs are concerned, Neon is the first instance of a chair meeting the design demands of today's world of working. As leader in innovation, bimos has managed to combine the technology and ergonomic requirements of production workplaces with an appealing and contemporary design. Neon takes innovative bimos design to the production environment.



Neon means clear lines

What strikes the observer first about the Neon is its flex strip running around the chair. It serves to emphasise its clear contour, and at the same time provides Neon with a distinctive face. It forms the connection between hard shell and comfortable core. But the flex strip is more than just a visual gimmick: it protects the chair and its environment and ensures that the joins in the material are smooth.

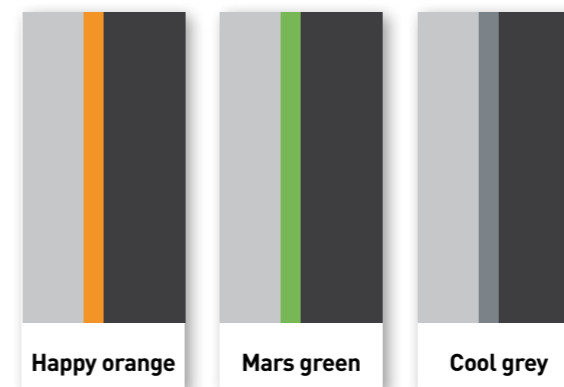

Neon means colour

Gone are the days when a workplace chair was expected to be conservative and mundane. Neon is forging new paths; it recognises colour as an emotional link between person and work. Here Neon has just one single mission: fun at work. In addition to the various upholstery colours, the flex strip is available in the following colours: **Happy orange, Mars green and Cool grey.**



Neon means freedom

In contrast to the office chair, workplace chairs always need to provide the user with maximum freedom of movement. An example is the tapered backrest. It allows sweeping movements without having to sacrifice the support of the back.



Neon is a PHOENIX

Neon is one of the first workplace chairs to have been defined in cooperation with top designers. The Stuttgart-based design company PHOENIX has created numerous classics of product and industrial design. Andreas Haug and Tom Schönherr, founders and owners of the company, define their design philosophy as an attitude. Among the basic values of this attitude are ethics and aesthetics, economy and ecology, precision and innovation. Neon emanates from that attitude. Neon is a PHOENIX.

Neon is green:
new concepts in
sustainability



Neon is an angel

Neon is the first workplace chair which has been awarded the Blue Angel eco-label.

- **Recycling starts as early as the development stage**
Neon is designed in such a way that almost complete material recovery is possible.
- **Quality is the best protection for resources**
Nothing is better for the environment than a product which does not have to be replaced. Neon has been designed for a very long life. This is why Neon comes with a five-year warranty.
- **Modular design as service-plus**
And if something should go wrong with Neon, all components can be replaced simply and quickly.
- **The 1+1 of sustainability**
Neon's innovative 1+1 system allows damaged upholstery to be replaced with just one click.
- **Neon has a green home**
As an Interstuhl brand, bimos has been a trailblazer in the field of environmentally compatible production since the nineties. Its rigorous environmental management system has been certified under EMAS and, of course, complies with the requirements of ISO standard 14001.
- **Green values in black and white**
The delivery of Neon includes an environmental data sheet. This shows the key environmental parameters of all components: from the humble screw to the upholstery.



Neon overview



Dimensions

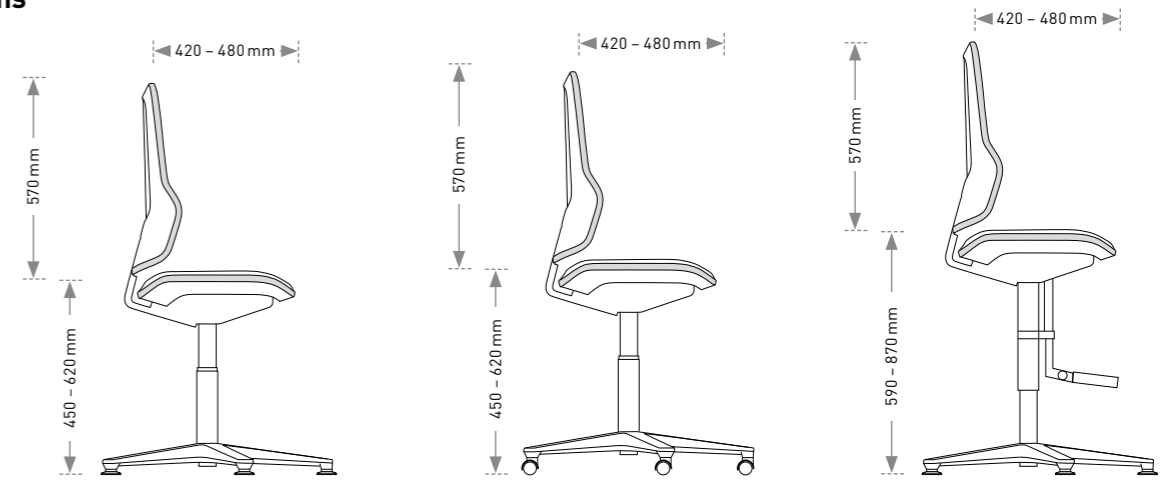

	Neon 1 with glides	Neon 2 with castors	Neon 3 high with mounting aid and glides
Seat height	450 - 620 mm	450 - 620 mm	590 - 870 mm
Seat width	470 mm	470 mm	470 mm
Seat depth	420 - 480 mm	420 - 480 mm	420 - 480 mm
Backrest height	570 mm	570 mm	570 mm
Ø base	700 mm	700 mm	700 mm



4D armrests

Order no. **9589**
Order no. [ESD] **9589E**

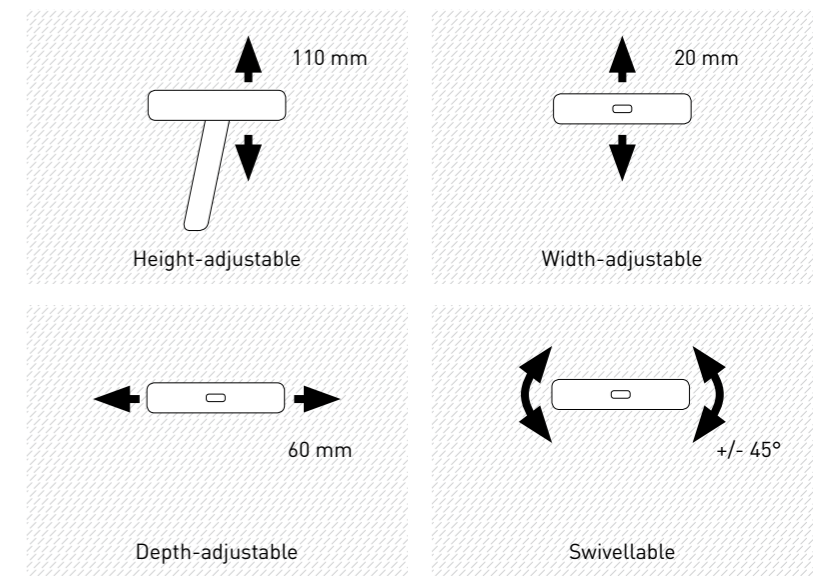

Certificates



Chair elements

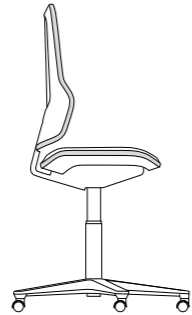

	Neon 1 with glides Seat height 450 – 620 mm		Neon 2 with castors Seat height 450 – 620 mm		Neon 3 high with mounting aid and glides Seat height 590 – 870 mm	
Version	Production and laboratory	ESD	Production and laboratory	ESD	Production and laboratory	ESD
	Order no.	Order no.	Order no.	Order no.	Order no.	Order no.
Permanent contact backrest	9560	9560E	9563	9563E	9561	9561E
Synchronous technology	9570	9570E	9573	9573E	9571	9571E
Features	Ergonomic package Seat height adjustment Seat inclination adjustment Seat depth adjustment Backrest height adjustment Aluminium base Black Optional: aluminium polished Backrest shell Basalt grey	Conforming to ESD standard EN 61340-5-1 Ergonomic package Seat height adjustment Seat inclination adjustment Seat depth adjustment Backrest height adjustment Aluminium base Black Optional: aluminium polished Backrest shell Black, conductive	Ergonomic package Seat height adjustment Seat inclination adjustment Seat depth adjustment Backrest height adjustment Aluminium base Black Optional: aluminium polished Castors for hard floors Backrest shell Basalt grey	Conforming to ESD standard EN 61340-5-1 Ergonomic package Seat height adjustment Seat inclination adjustment Seat depth adjustment Backrest height adjustment Aluminium base Black Optional: aluminium polished Castors for hard floors Backrest shell Black, conductive	Ergonomic package Seat height adjustment Seat inclination adjustment Seat depth adjustment Backrest height adjustment Aluminium base Black Optional: aluminium polished Mounting aid height-adjustable and folded up Backrest shell Basalt grey	Conforming to ESD standard EN 61340-5-1 Ergonomic package Seat height adjustment Seat inclination adjustment Seat depth adjustment Backrest height adjustment Aluminium base Black Optional: aluminium polished Mounting aid height-adjustable and folded up Backrest shell Black, conductive



Flex strip



Happy orange (standard) Order no. 3279



Mars green

Order no. 3280



Cool grey

Order no. 3278



Upholstery element

Order no. **9588**
Order no. (ESD) **9588E**

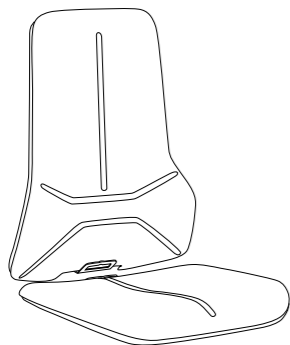

Taff fabric

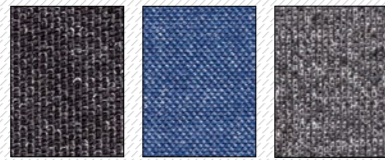

Black **TA01** Blue **TA02** Grey **TA11**

for ESD **TL01** for ESD **TL02** for ESD **TL11**

Magic synthetic leather



Black **MG01** Blue **MG02** Grey **MG11**

for ESD **MG01**

Integral foam

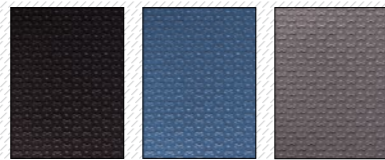

Black **2000** Blue **2001** Grey **2002**

for ESD **2000**

Superfabric

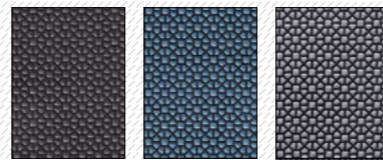

Black **SP01** Blue **SP02** Grey **SP11**



Your bimos partner

Any questions on Neon, looking for a contact, or would you like to experience Neon in motion? We will be pleased to help:

www.bimos.de

bimos – a brand of

Interstuhl Büromöbel GmbH & Co. KG
Brühlstraße 21 | D 72469 Meßstetten-Tieringen
Telephone: +49 (0) 74 36 - 8 71 - 0 | Fax: +49 (0) 74 36 - 8 71 - 359
info@bimos.de | www.bimos.de

